

KUSTOM[®]

OWNER'S MANUAL G410H



Congratulations on the purchase of your new Kustom bass guitar speaker cabinet! Your new G410H has been designed to offer exceptional sound quality and long-term performance reliability. Inside this manual you'll find detailed information regarding the cabinet's features. We wish you many years of enjoyment with your Kustom G410H.

Product Contents

These items are included with your G410H speaker cabinet.
Be sure to contact your dealer if any items are missing.

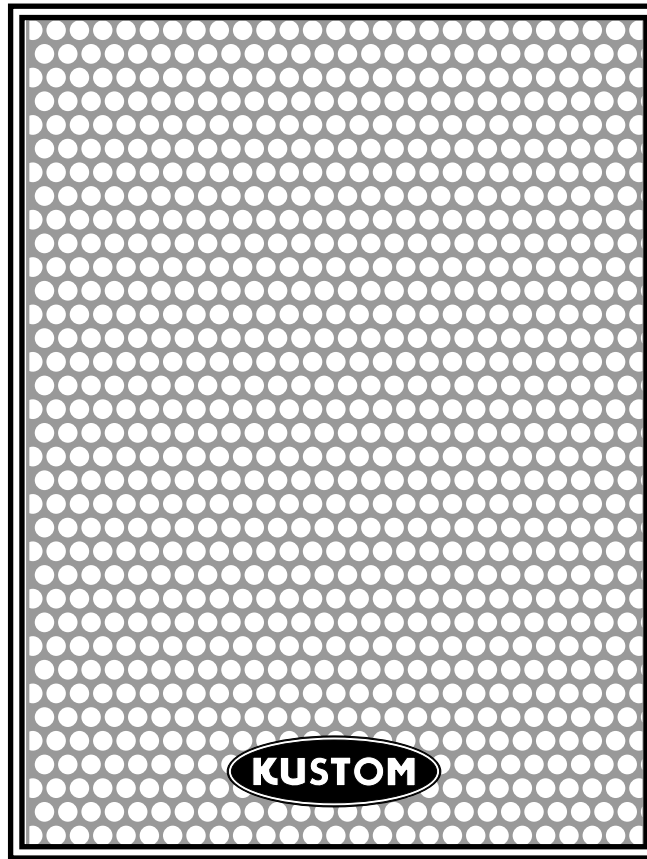

G410H

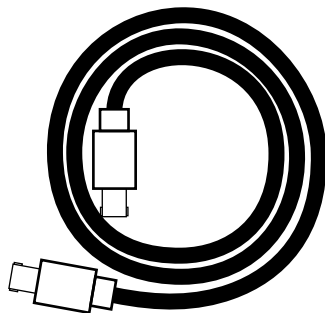

**Speaker Cable
KAC-GRVSCC**

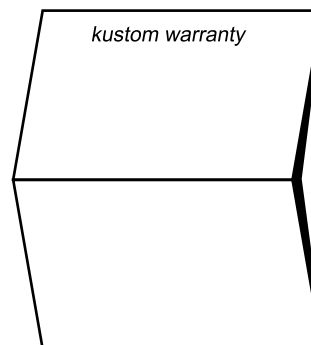

Warranty Card

Rear Panel

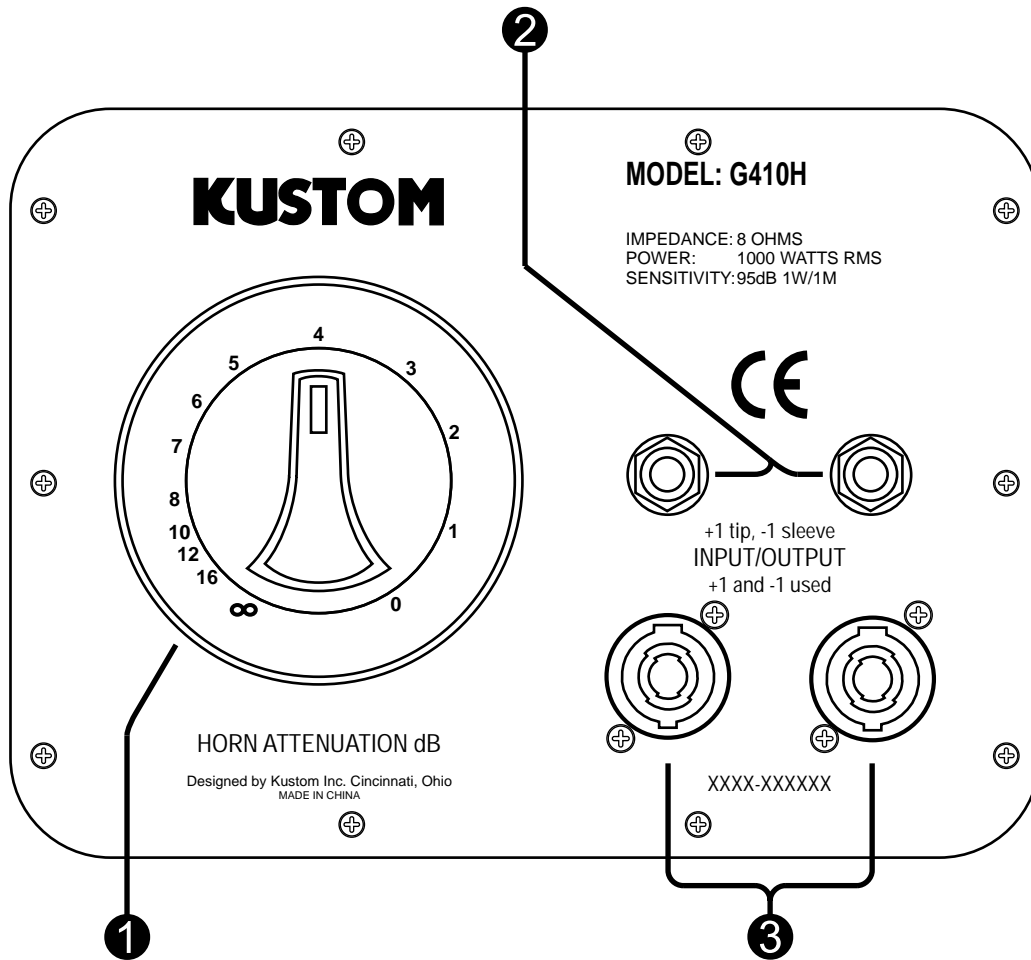

① Horn Attenuator:

This is a “volume” control for the horn. To disable the horn, turn the knob counter clockwise until the indicator reaches ∞ . To set the horn for maximum output, turn the knob clockwise until the indicator reaches **0**.

② Speaker Input/Output:

These jacks can be used as an input and/or output. The jacks accept a standard 1/4” cable. **Note:** When using these jacks as an output to another cabinet, refer to the Amplifier Loading Chart (page 4) for important amplifier loading information.

③ Speaker Input/Output:

These jacks can be used as an input and/or output. They accept standard Speakon® type speaker cables. To connect a cable: Insert and twist one quarter turn clockwise until the release button locks. To remove a cable: Pull back release button on cable connector, twist connector counter clockwise one quarter turn, and pull out connector. **Note:** When using these jacks as an output to another cabinet, refer to the Amplifier Loading Chart (page 4) for important amplifier loading information.

Speaker Connection Diagram

(Shown using the Kustom GROOVE 1200 amplifier)

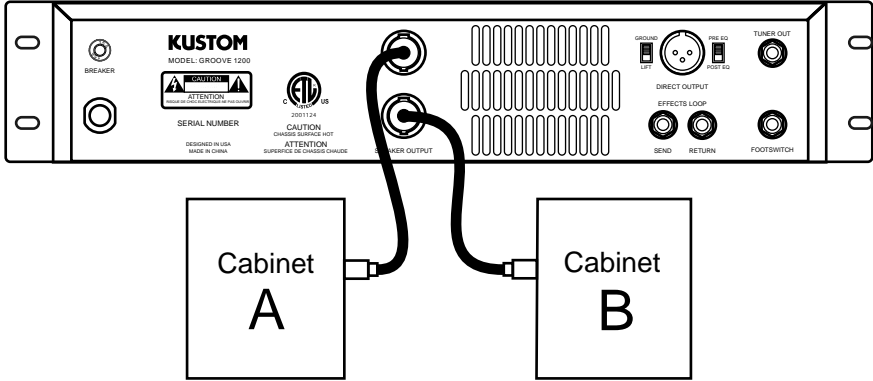

Amplifier Loading Chart

Speaker cabinet loads (ohms) applied to the amplifier		Cabinet A's Impedance (ohms)							
		open	16	8	5.33	4	3.20	2.67	2
Cabinet B's Impedance	open	open	16	8	5.33	4	3.2	2.67	2
	16	16	8.00	5.33	4.00	3.20	2.67	2.29	1.78
	8	8	5.33	4.00	3.20	2.67	2.29	2.00	1.60
	5.33	5.33	4.00	3.20	2.67	2.29	2.00	1.78	1.45
	4	4	3.20	2.67	2.29	2.00	1.78	1.60	1.33
	3.20	3.2	2.67	2.29	2.00	1.78	1.60	1.46	1.23
	2.67	2.67	2.29	2.00	1.78	1.60	1.46	1.34	1.14
	2	2	1.78	1.60	1.45	1.33	1.23	1.14	1.00
		Total load on amplifier Note: Refer to amplifier specifications for proper loading information.							

This chart can help you determine what load (ohms) is present on the amplifier when using multiple cabinets.

- To use this chart with two cabinets (A and B), find cabinet A's impedance (ohms) column and cabinet B's impedance row on the chart. The total load on the amplifier is shown in the box where they meet. For example: If cabinet A's impedance is 8 ohms and cabinet B's impedance is 4 ohms, the total load on the amplifier would be 2.67 ohms.
- To use this chart with three or more cabinets, find the total load for two cabinets and then use the result for cabinet A's impedance column. The third cabinet will then be used for cabinet B's impedance row on the chart. Find the total load on the amplifier and repeat if more cabinets are used. For example (using 3 cabinets): If the first cabinet (cabinet A) has an impedance of 16 ohms and the second (cabinet B) has an impedance of 8 ohms, the total load would be 5.33 ohms. Using this load (5.33) as cabinet A's impedance and a third cabinet's (new cabinet B) impedance of 4 ohms, you would find that the total load on the amplifier is 2.29 ohms. **Note:** It is not recommended to use any combination of cabinets that has a resulting load in a shaded area of the chart.

Alternate Connection Diagrams

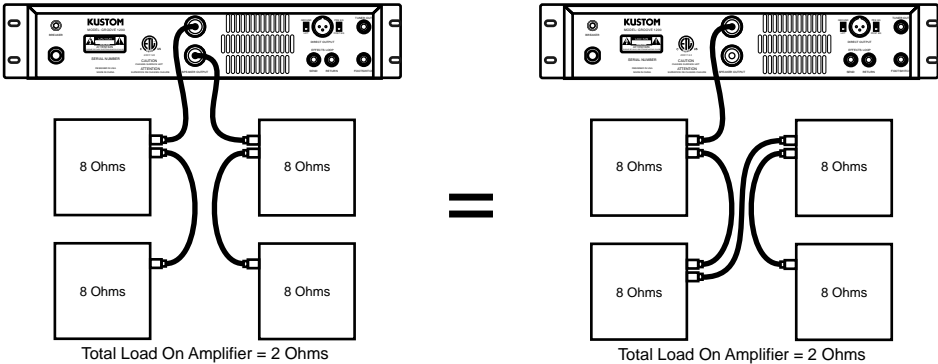

G410H

Specifications

Model	Groove 410H	Bass guitar speaker cabinet
Input Power	1000 Watts	RMS
Impedence	8 Ohms	
Speakers	4 X 10"	Specially Designed Eminence® Speakers
Sensitivity per speaker	95dB 1W at 1 meter	Average sensitivity 35-5Khz using factory test conditions
Frequency Response	40HZ-15kHz	System Response
Dimensions	mm/kg	820 (Height) x 617 (Width) x 510 (Depth), 46.4 kg
	Inches/Pounds	32.25 (Height) x 24.25 (Width) x 20.125 (Depth), 102.3 lbs
Accessories Included	Speakon Cable	3 meter Speakon speaker cable

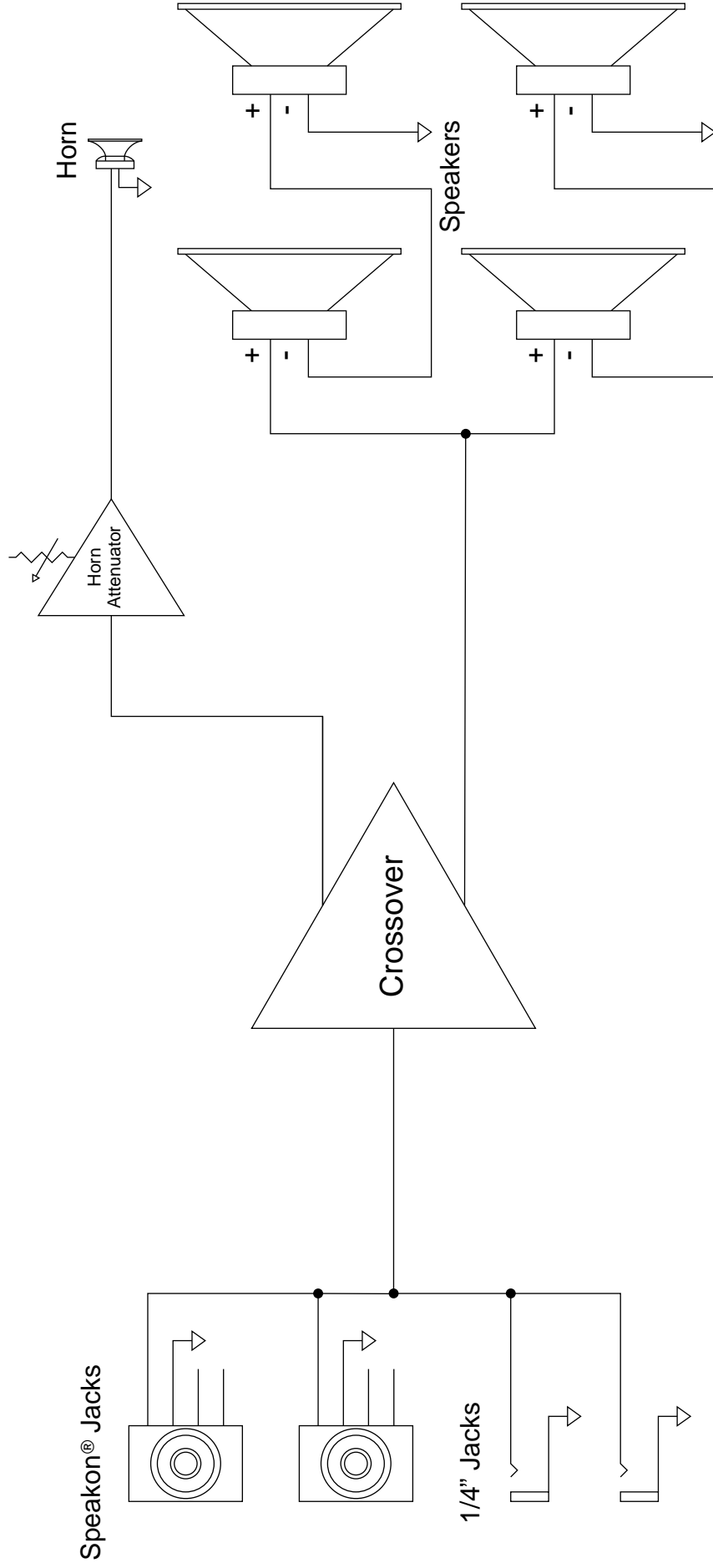

Signal Flow Diagram

KUSTOM[®] Kustom Amplification Inc., PO BOX 568, Hebron, KY • USA
888-4-KUSTOM (888-458-7866) Web: www.kustom.com

